

POS X

POINT OF SALE
PERFECTED

EVO

TP2 TouchPC

Designed to set a New Standard for Value, the EVO TouchPC 2 by POS-X combines a sleek new look, ultra stable Intel Atom processor and solid fanless construction at a price point to fit all budgets. Powerful yet energy efficient, the EVO TouchPC is the perfect choice for retail, restaurant or warehouse applications.



EVO TOUCHPC

Key Features

- Stable Intel Atom 1.6ghz Processor
- Up to 2GB DDRII RAM
- 15" Active Matrix Touch Display
- Fanless - Ideal for Dusty or Dirty Environments
- Energy Efficient - Maximum 65 Watt Power Consumption
- Optional Integrated MSR, Customer Display or 8.4" Rear LCD
- 3 Year Advanced Replacement Protection

EVO TouchPC Specifications

PART NUMBER	EVO-TP2	
MOTHERBOARD	C36	
CPU	Intel® Atom N270 procesor 1.6Ghz	
Chip Set	Intel® 945 GSE Express + ICH7M	
System Memory	1~2 GB DDR II	
Video	Integrated Intel® GMA® 950 Graphics Engine up to 224 MB shared	
PORTS		
USB	4 x USB2	
Serial	4 xRJ 47 COM (Com1, Com2, Com3 RS232 Com4 with 5V/12V)	
LAN	1 Realtek RTL8111C-GR 10/100/1000 baseT LAN	
VGA	1 x Additional VGA Port	
Cash Drawer Port	1 x RJ11 (12V/24V cash drawer)	
HARD DRIVE	2.5" 250GB OR 16GB SSD	
PHYSICAL		
Housing	ABS	
Weight with Base	12.13 lbs	
Dimensions with Base	14.37" (w) x 10.94" (D) x 11.69" (H)	
VESA Wall Mountable	NO	YES SSD 75 mm x 75mm
Tilt Angle	0° to 90°	
Housing Color	Black	
LCD Display	15" 1024 x 768 pixel, 16.7M colors 250 nit	
Touch Screen	5-Wire Resistive, 35+ millions taps per location	
ELECTRICAL	Ext. 65W 19V 3.4 A	
ENVIRONMENTAL		
Temperature	41°F to 95°F operating	
Humidity	20% - 80% non-condensing	
WARRANTY	3 Year Limited	
CERTIFICATIONS	FCC, CE, LVD, RoHs	
OPERATING SYSTEM	None/ WIN 2000/WIN 2000 Pro/XP Home/XP Professional/VISTA/Linux/ Windows Embedded	

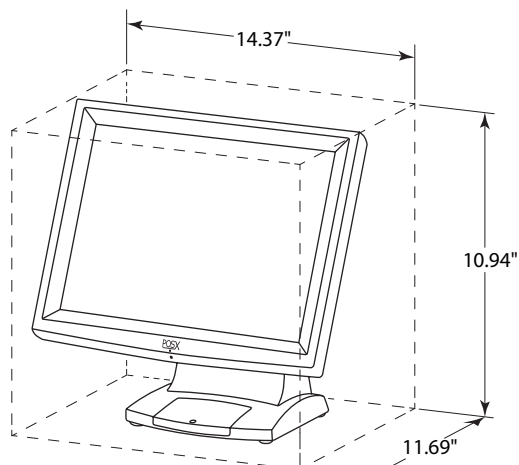

ACCESSORIES	
EVO-MR2	3 Track MSR with USB interface
EVO-RD2-VFD	Integrated Customer Display
EVO-RD2-LCD8	Integrated Rear Display, 8.4" LCD, VGA
EVO-XZ1-M75	Universal VESA Mount for All TouchPC & Touch Monitors